

Instruction Manual for TUMAX® DSL986AFZ series

Thank you for purchasing TUMAX products.

This is an innovative designed electronic flash for both digital cameras and film cameras. The features are leading photography into digital era. Advanced technology is used in the flash to control the correct amount of light output. Please kindly take few minutes to read the instruction manual before using.

Digital TTL / Auto Focus flash for:

- C** - Canon Digital E-TTL, E-TTL II cameras & E-TTL film cameras
- N** - Nikon Digital TTL, i-TTL cameras & TTL, i-TTL film cameras
- OP** - Olympus & Panasonic Digital TTL cameras
- P** - Pentax Digital P-TTL & film cameras
- SA** - Sony Alpha & Minolta Digital ADI, D Lenses cameras & TTL film cameras

Characteristics

- LED light beam for low light focusing
- Automatic shutter speed setting
- Flash readiness indication
- Red-eye reduction (Type N, OP and P)
- Front and rear curtain synchronization
- Power saving function

Special Mounting Foot for SA and OP flash

Type SA Mounting foot



Type OP Mounting foot

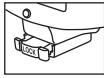

Auto Focus Lens
Lock Ring
Mounting Foot

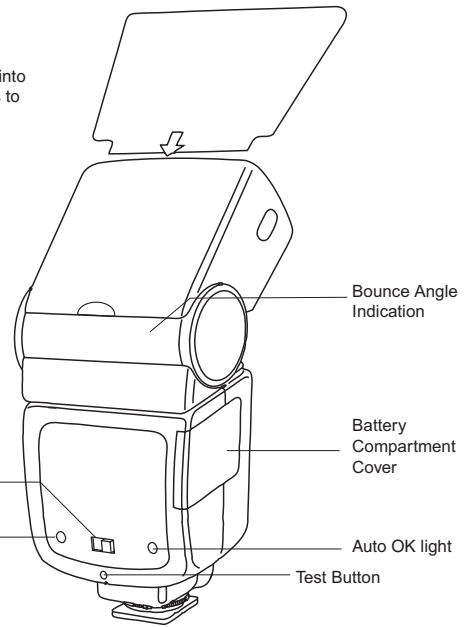
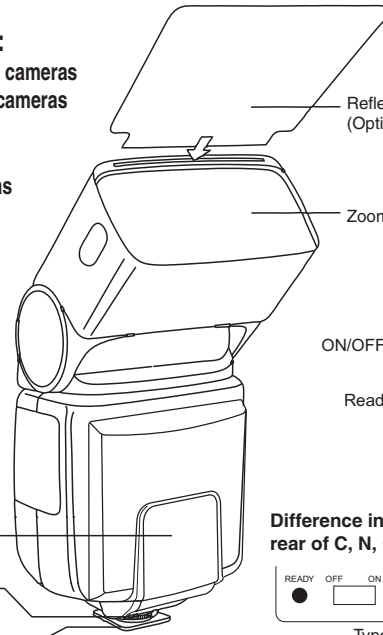

Difference in the position of indicators and switch at the rear of C, N, OP, P & SA flash

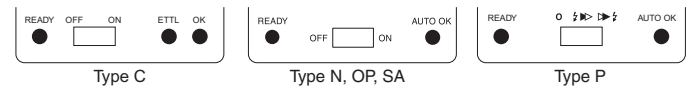

Specifications

Guide No. (ISO 100)	42(m) at 85mm position
Flash Head	28-35-50-85mm
Bounce Angle	0°, 45°, 60°, 75°, 90°
Swivel Angle	Right 0° - 90°; Left 0° -180°
Power source	Four 1.5V AA size batteries (R6, LR6)
Recycling time	0.5-8 sec.
Dimensions	Approx. 72 (W) x 102 (D) x 130 (H) mm
Weight w/o battery	Approx. 260g

Specifications and design are subject to change without notice.

LOADING BATTERIES

Make sure the On / Off Switch is in Off position. Slide open the Battery Compartment Cover and insert 4 x AA batteries as symbols indicated in the battery compartment. Close the Battery Compartment Cover. Wrong polarities may cause batteries to heat up, leak, explode and damage the flash. When needed to replace batteries, make sure all batteries are of same brand, type and same capacity.

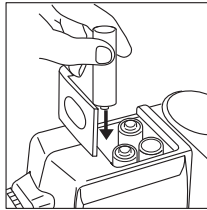

MOUNTING FLASH TO THE CAMERA

- For Type C, N & P flash: Loosen the lock ring. Slide the flash into camera accessory shoe. Tighten the flash with the lock ring.
- For Type OP flash: Insert the mounting foot of the flash into camera accessory shoe and press "LOCK" to lock the flash in place.
- For Type SA flash: Insert the mounting foot of the flash into camera accessory shoe. Then the flash is locked in place.

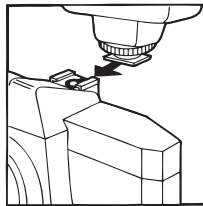

REMOVING THE FLASH

- For Type C, N & P flash: Loosen the lock ring and remove the flash off backwards.
- For Type OP flash: Press both sides of the Lock/Release Button towards the direction indicated by arrow symbols and then take the flash off backwards.
- For Type SA flash: Push the Shoe Release Button and pull the flash off backwards.

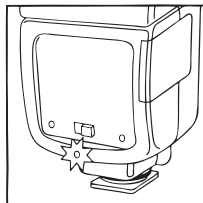

OPERATING THE FLASH WITH CAMERA

- Slide the ON/OFF switch to the "ON" position. After a few seconds the Ready lamp should glow, thereby indicating that the flash is ready to shoot. Press the Test button to make sure that your flash works properly. If the flash discharges, wait until the Ready lamp glows again.
- Adjust your camera to the appropriate setting. Most cameras can be set to the program position (See your camera's manual for details on flash synchronization.) When the flash is ready to fire, it will automatically match the camera's shutter speed. The flash readiness indicator will appear on the camera. Different camera models indicate flash readiness in different ways (see your camera's manual).
- Point the digital camera at the subject and focus. Gently press the shutter button on the camera to check the image. Then press the shutter button firmly. The Auto OK indicator will light when the picture is exposed correctly.

AF / TTL OPERATION

AF - AUTO FOCUS

If the camera is equipped with an external AF mode, then slightly press the shutter button, the flash's AF assist LED light is automatically activated to help the camera to focus properly when the subject is in darkness.

TTL

The flash performs pre-flashes for camera to calculate the intensity of flash light output. Then the flash light output is controlled precisely.

-For Nikon D40 & D40x owners: The flash can support an ISO speed up to 800 in full auto mode. It may not perform as expected if the ISO speed exceeds the supported range.

RED-EYE REDUCTION (Type N, OP & P)

Red-eye reduction function reduces the red-eye phenomenon by emitting pre-flashes before the main flash. To set up this function, please refer to camera instruction manual.

Wide Angle Diffuser (Optional)

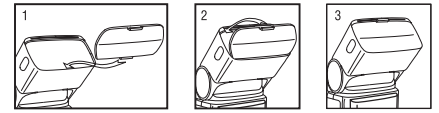
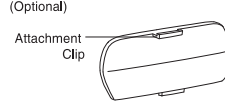

FRONT AND REAR CURTAIN SYNCHRONIZATION

Some cameras offer the option of rear curtain synchronization (Rear mode) triggering the flash unit at the end of the exposure time. Rear curtain synchronization is particularly advantageous when using slow shutter speeds (slower than 1/30 sec.) or when shooting moving objects that have their own source of light. Rear curtain synchronization gives a more realistic impression of movement because the light streaks behind the light source instead of building up in front of it, as is the case when the flash is synchronized with the front shutter curtain. Depending on its operation mode, the camera uses shutter speeds slower than its sync speed.

For Type P flash: You could select the synchronization mode as either front curtain (⚡▶) or rear curtain (▶⚡) at the back of the flash. The flash will fire according to the mode selected to match with the camera shutter.

For Type C, N, OP, SA flash: The camera controls front or rear-curtain synchronization, therefore no setting is required to be done on the flash.

Note: The rear curtain synchronization is only possible on cameras with this feature. See your camera's instruction manual for details.

POWER SAVING FUNCTION

If there is no communication between the flash and the camera for around 3 minutes, the flash will automatically be switched to power saving mode in order save battery power. The Ready light will be off while in power saving mode.

To reactivate the flashgun, simply press your camera's shutter or switch the main switch off and on again.

The flashgun is not completely switched off in power saving mode. However, power consumption is drastically reduced. If you are not going to use your flashgun for a while, we recommend you to turn the flash off.

BOUNCE AND SWIVEL FLASH

Using direct flash to illuminate a subject will result in harsh, unnatural and unattractive shadows. This can be avoided by bounce and/or swivel flash. The flash head of DSL986AFZ can be tilted to an angle of 45°, 60°, 75°, or 90° and rotated horizontally 180° to the left and 90° to the right. You can tilt or rotate the flash head to bounce the light off the ceiling or walls. While shooting indoor, this technique can help to create more natural-looking pictures of people with softer shadows.

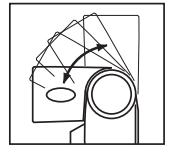

In order to have your pictures correctly exposed using bounce or swivel flash, the following is recommended to users:

- (1) Select white or reflective surfaces to bounce the light off. Otherwise your pictures will come with an unnatural color cast similar to that of the reflecting surface.
- (2) Set the camera's exposure mode to Aperture Priority Auto ("A") or Manual ("M")
- (3) Use a wider aperture than normally do, as 2 or 3 stops of light can be lost when using bounce or swivel flash

ZOOM HEAD

The zoom flash head covers the focal length of 28-35-50-85mm in four stops. To choose these positions, simply move the flash head as shown.

Note: Make sure the flash is set the focal length equal to or wider than the camera lens focal length to assure proper coverage.

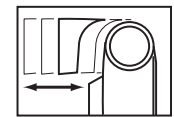

CAUTIONS

- The flash unit does not function on camcorders.
- Misfiring sometimes occurs when the power switch is turned on and off continuously. If it happens, power off the flash unit for few seconds before switching it on again. The flash unit will then work as normal.
- Do not leave or store the flash unit in temperature exceed 40°C. This might adversely affect the internal structure or performance of the flash unit. Particularly, do not leave the flash unit in the automobiles during summer.
- Remove the batteries if you do not intend to use the flash unit for a long period of time.
- The flash unit is not water-resistant. Rain and humid weather may cause irreparable damages to the flash.
- The flash unit is composed of very delicate electronic parts. It should be protected against shocks, falls or other improper handling.
- The flash unit contains a high voltage condenser. Do not try to open the housing or repair the flash.
- Do not clean the surface of flash unit by any petrol, detergent solution or strong solvents. These solvents may cause damages to the flash.

